









Accessories / Assembly kits for leak detectot type D9:

Artikelnr. Part.No.	Description	Material	
49000190	PVC hose clear (suction line) 4x2 mm, 100m roll	PVC	
49000192	PVC hose RED (measuring line) 4x2 mm, 100m roll	PVC	
49000690	PVC hose clear (suction line) 6x2 mm, 100m roll	PVC	
49000195	PVC hose RED (measuring line) 6x2 mm, 100 roll	PVC	
29022425	Hose clamp for tube 8mm outside diameter		
29022426	Hose clamp for tube 10mm outside diameter		
49001055	Air dryer 180 ccm (attachment to leak detector, new version), without dry beads	Plastics	
49001056	Air dryer 350 ccm (attachment to leak detector, new version), without dry beads	Plastics	

Accessories / Assembly kits for leak detector type D9:

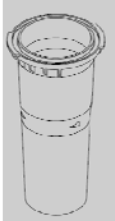
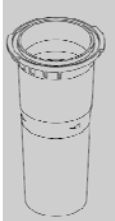
Artikelnr. Part.No.	Description	Material	
49300090	Dry beads 250 ccm		
49300086	Dry beads 1 ltr.		
49300087	Dry beads 2 ltr.		
49300088	Dry beads 10 ltr.		
42001132	Tank connector kit for leak detector type D9 , connected to: - above or underground double walled tanks Consist of: - 2 pcs. tank connectors, 1 inch , material brass - 2 hose clips - for 4 mm inside hose diameter	Brass	
42001168	Assembly kit for leak detector type D9 for assembly to double walled tanks pressure line and measuring line, consisting of - 2 pcs connectors for tank 3/4" and - 4 mm (inside hoseØ) - material brass	Brass	
42001063	Adapter kit for leak detector type D9 , connected to: - double walled tanks Consist of: - 2 pcs tank connectors 1 inch - connector for 6 mm outside tubing diameter - material: brass	Brass	
42003578	Air dryer (external) for leakdetector type D9, D29, 180ccm , with mounting angle, connectors for 4mm (inside hoseØ), without dry beads	Plastics	
42003589	Air dryer (external) for leakdetector type D9, D29, 350ccm , with mounting angle, connectors for 4mm (inside hoseØ), without dry beads	Plastics	

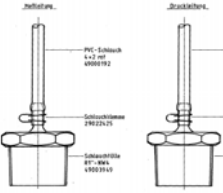
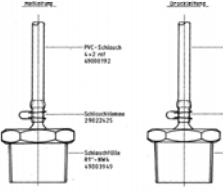
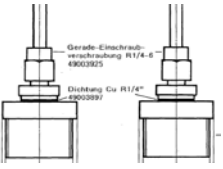
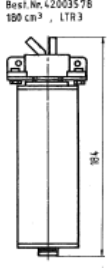
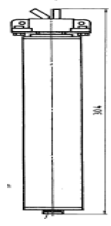
Accessories / Assembly kits for leak detectot type D9:

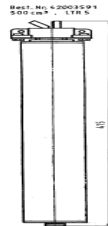
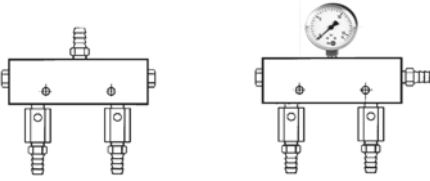
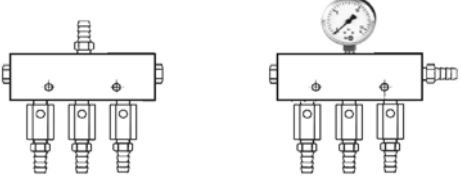
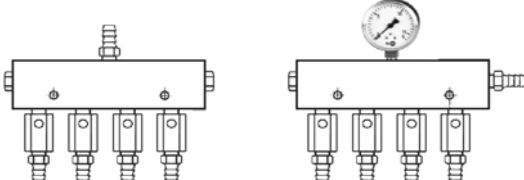
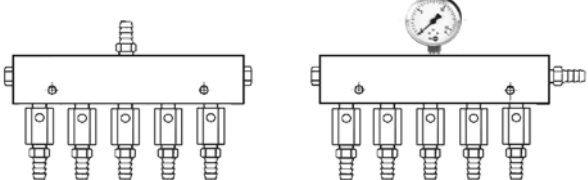
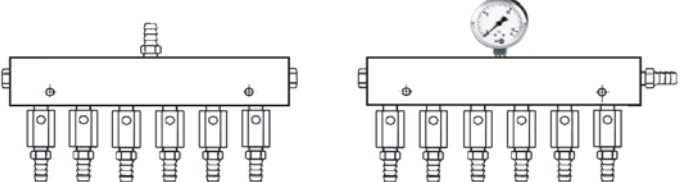
Artikelnr. Part.No.	Description	Material	
42003591	Air dryer (external) for leakdetector typeD9, D29, 550ccm , with mounting angle, connectors for 4mm (inside hoseØ), without dry beads	Plastics	
42003122	Manifold kit for leak detector type D9 , connected to: - 2 underground double walled tanks Consist of: - 1 pc pressure line manifold - 1 pc measuring line manifold with manometer 1 bar, each with - exit line ball valves, - connectors for 4 mm (inside hoseØ)	Brass	
42003123	Manifold kit for leak detector type D9 , connected to: - 3 underground double walled tanks Consist of: - 1 pc pressure line manifold - 1 pc measuring line manifold with manometer 1 bar, each with - exit line ball valves, - connectors for 4 mm (inside hoseØ)	Brass	
42003124	Manifold kit for leak detector type D9 , connected to: - 4 underground double walled tanks Consist of: - 1 pc pressure line manifold - 1 pc measuring line manifold with manometer 1 bar, each with - exit line ball valves, - connectors for 4 mm (inside hoseØ)	Brass	
42003125	Manifold kit for leak detector type D9 , connected to: - 5 underground double walled tanks Consist of: - 1 pc pressure line manifold - 1 pc measuring line manifold with manometer 1 bar, each with - exit line ball valves, - connectors for 4 mm (inside hoseØ)	Brass	
42003126	Manifold kit for leak detector type D9 , connected to: - 6 underground double walled tanks Consist of: - 1 pc pressure line manifold - 1 pc measuring line manifold with manometer 1 bar, each with - exit line ball valves, - connectors for 4 mm (inside hoseØ)	Brass	

Accessories / Assembly kits for leak detector type D9:

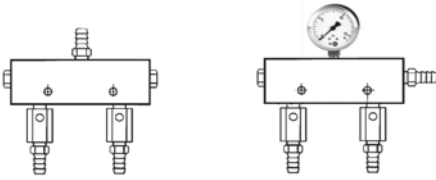
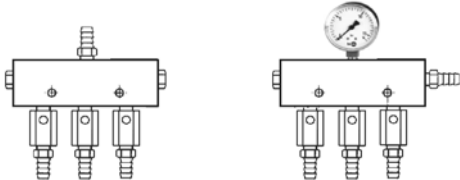
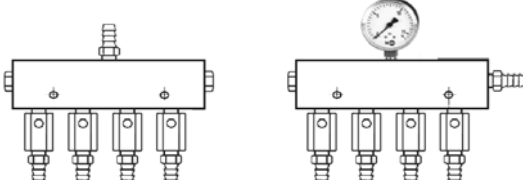
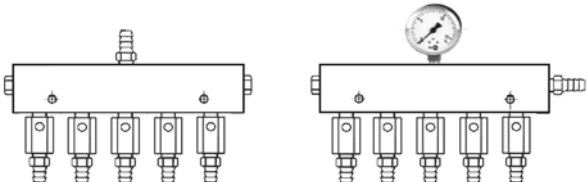
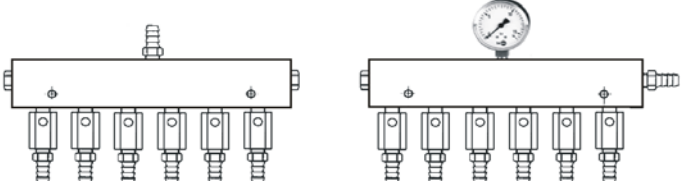
Artikelnr. Part.No.	Description	Material	
42003132	<p>Manifold kit for leak detector type D9, connected to: - 2 underground double walled tanks Consist of: - 1 pc pressure line manifold - 1 pc measuring line manifold with manometer 1 bar, each with - exit line ball valves, - connectors for 6 mm (inside hoseØ)</p>	Brass	
42003133	<p>Manifold kit for leak detector type D9, connected to: - 3 underground double walled tanks Consist of: - 1 pc pressure line manifold - 1 pc measuring line manifold with manometer 1 bar, each with - exit line ball valves, - connectors for 6 mm (inside hoseØ)</p>	Brass	
42003134	<p>Manifold kit for leak detector type D9, connected to: - 4 underground double walled tanks Consist of: - 1 pc pressure line manifold - 1 pc measuring line manifold with manometer 1 bar, each with - exit line ball valves, - connectors for 6 mm (inside hoseØ)</p>	Brass	
42003135	<p>Manifold kit for leak detector type D9, connected to: - 5 underground double walled tanks Consist of: - 1 pc pressure line manifold - 1 pc measuring line manifold with manometer 1 bar, each with - exit line ball valves, - connectors for 6 mm (inside hoseØ)</p>	Brass	
42003136	<p>Manifold kit for leak detector type D9, connected to: - 6 underground double walled tanks Consist of: - 1 pc pressure line manifold - 1 pc measuring line manifold with manometer 1 bar, each with - exit line ball valves, - connectors for 6 mm (inside hoseØ)</p>	Brass	

Accessories / Assembly kits for leak detector type D9:

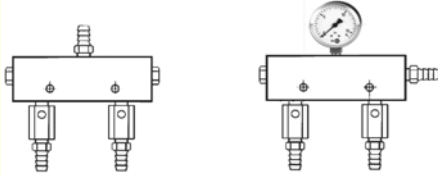
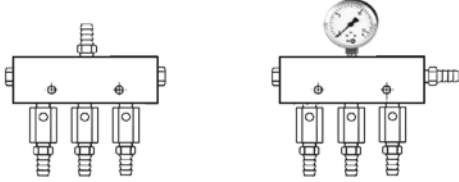
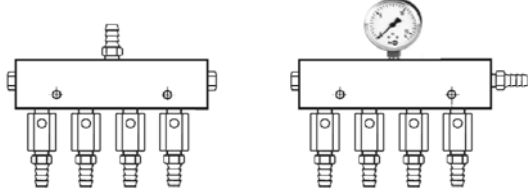
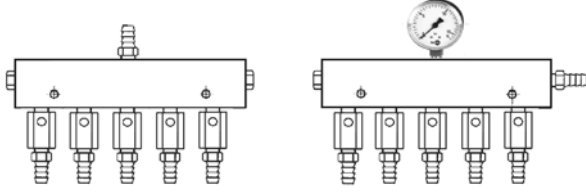
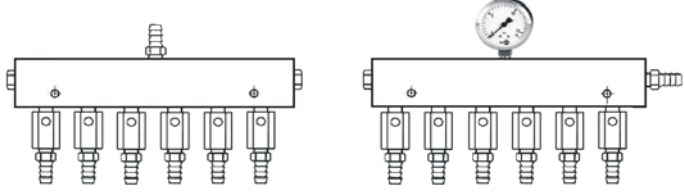
Artikelnr. Part.No.	Description	Material	
42003112	Manifold kit for leak detector type D9 , connected to: - 2 underground double walled tanks Consist of: - 1 pc pressure line manifold - 1 pc measuring line manifold with manometer 1 bar, each with - exit line ball valves, - connectors for 8 mm outside tubing diameter	Brass	
42003113	Manifold kit for leak detector type D9 , connected to: - 3 underground double walled tanks Consist of: - 1 pc pressure line manifold - 1 pc measuring line manifold with manometer 1 bar, each with - exit line ball valves, - connectors for 8 mm outside tubing diameter	Brass	
42003114	Manifold kit for leak detector type D9 , connected to: - 4 underground double walled tanks Consist of: - 1 pc pressure line manifold - 1 pc measuring line manifold with manometer 1 bar, each with - exit line ball valves, - connectors for 8 mm outside tubing diameter	Brass	
42003115	Manifold kit for leak detector type D9 , connected to: - 5 underground double walled tanks Consist of: - 1 pc pressure line manifold - 1 pc measuring line manifold with manometer 1 bar, each with - exit line ball valves, - connectors for 8 mm outside tubing diameter	Brass	
42003116	Manifold kit for leak detector type D9 , connected to: - 6 underground double walled tanks Consist of: - 1 pc pressure line manifold - 1 pc measuring line manifold with manometer 1 bar, each with - exit line ball valves, - connectors for 8 mm outside tubing diameter	Brass	
	Other manifolds / connectors on request -		

Accessories / Assembly kits for leak detectot type D9:

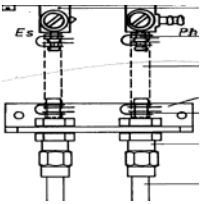
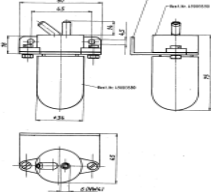
Artikelnr. Part.No.	Description	Material	
42001140	Adapter kit for leak detector type D9 , connected to: - double walled tanks - in combination with p/n 42001063 Consist of: - 2 pcs adapters, 4 mm inside hoseØ / 6mm outside tubingØ - fixing plate	Brass	
42005150	Condensate vessel for leakdetector type IIIIF, IVF, V13 single, 1x 34 ccm , with mounting angle, connectors for 4 mm (inside hoseØ) , for assembly to the lowest point of the connecting tubes	Plastics	
42005154	Condensate vessel for leakdetector type IIIIF, IVF, V13, D9 single, 1x 80 ccm , with mounting angle, connectors for 4 mm (inside hoseØ) , for assembly to the lowest point of the connecting tubes	Plastics	